

400F TV Fresnel Day Light

▶ Photometric Data

Color Temperature: 5600K

TLCI: 95

CRI: 97 .max

Fan mode: Silent

Dimming Curve: S-curve

Ta: 25 °C





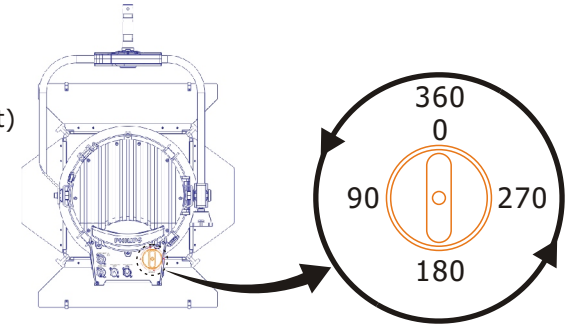

ZOOM Range: 12-45 deg(4 & 1/2 Turns)

12 deg zoom out (anti-clockwise to zoom out)

45 deg zoom in (clockwise to zoom in)



Illuminance

Distances	3m/9.8ft	5m/16.4ft	7m/23.0ft	9m/29.6ft	11m/36.2ft	Distances	3m/9.8ft	5m/16.4ft	7m/23.0ft	9m/29.6ft	11m/36.2ft
	Spot position, 12deg										
	12° 1/2					32deg(1 more turn to focus knob)					
	19° 1/10					32° 1/2					
						41° 1/10					
Center Beam	25114lx	9041lx	4612lx	2790lx	1868lx	Center Beam	4871lx	1753lx	894lx	541lx	362lx
CCT	5733K	5733K	5733K	5733K	5733K	CCT	5986K	5986K	5986K	5986K	5986K
	15deg(1 turn to focus knob)										
	15° 1/2					42deg(1 more turn to focus knob)					
	24° 1/10					42° 1/2					
						51° 1/10					
LUX	18690lx	6728lx	3432lx	2079lx	1390lx	Center Beam	3117lx	1122lx	572lx	346lx	232lx
CCT	5925K	5925K	5925K	5925K	5925K	CCT	5889K	5889K	5889K	5889K	5889K
	24deg(1 more turn to focus knob)										
	24° 1/2					45deg(1 more turn to focus knob)					
	32° 1/10					45° 1/2					
						54° 1/10					
Center Beam	9102lx	3276lx	1671lx	1011lx	677lx	Center Beam	2741lx	986lx	503lx	305lx	203lx
CCT	6038K	6038K	6038K	6038K	6038K	CCT	5858K	5858K	5858K	5858K	5858K

**All rights reserved, any of improvement made values changed on this table are without prior notice.