

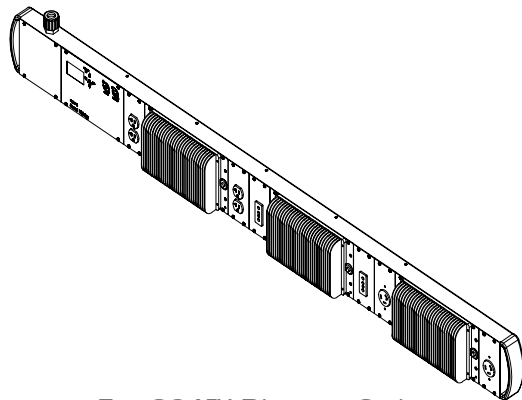

INSTALLATION & OPERATION GUIDE

S21™ & eS21™ DIMMING SYSTEM



For S21™ Dimmer Strips
71500 / 71501 / 71502

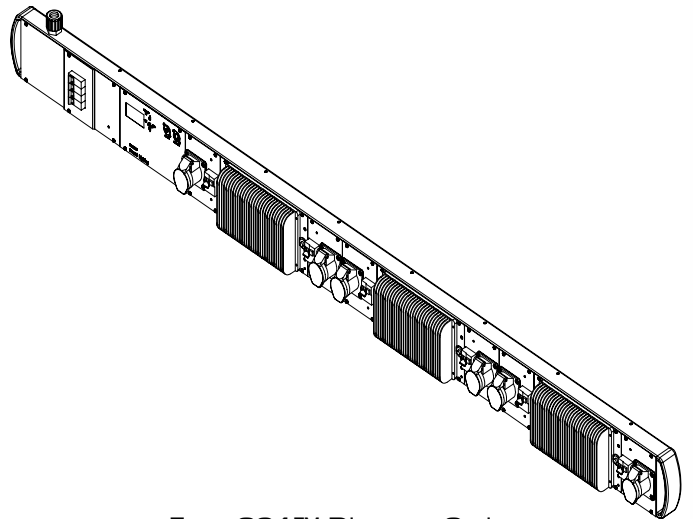

For eS21™ Dimmer Strips
71600 / 71601 / 71602

Strand Lighting - Dallas

10911 Petal Street
Dallas, TX 75238
Tel: 214-647-7880
Fax: 214-647-8030

Strand Selecon - Auckland

19-21 Kawana Street
Northcote, Auckland 0627
New Zealand
Tel: +64 9 481 0100
Fax: +64 9 481 0101

Strand Lighting - New York

267 5th Ave, 4th Floor
New York, NY 10016
Tel: 212-213-8219
Fax: 212-532-2593

Strand Lighting - Europe

Marssteden 152
Enschede 7547 TD
The Netherlands
Tel: +31 53 4500424
Fax: +31 53 4500425

Strand Lighting - Asia Limited

Room 6-10, 20/F Delta House 3 On Yiu Street
Shatin, N.T. Hong Kong
Tel: + 852 2757 3033
Fax: + 852 2757 1767

Website:

www.strandlighting.com

The material in this manual is for information purposes only and is subject to change without notice. Strand Lighting assumes no responsibility for any errors or omissions which may appear in this manual. For comments and suggestions regarding corrections and/or updates to this manual, please visit the Strand Lighting web site at www.strandlighting.com or contact your nearest Strand Lighting office.

El contenido de este manual es solamente para información y está sujeto a cambios sin previo aviso. Strand Lighting no asume responsabilidad por errores o omisiones que puedan aparecer. Cualquier comentario, sugerencia o corrección con respecto a este manual, favor de dirijirlo a la oficina de Strand Lighting más cercana.

Der Inhalt dieses Handbuches ist nur für Informationszwecke gedacht, Aenderungen sind vorbehalten. Strand Lighting uebernimmt keine Verantwortung für Fehler oder Irrtuemer, die in diesem Handbuch auftreten. Für Bemerkungen und Verbesserungsvorschlaege oder Vorschlaege in Bezug auf Korrekturen und/oder Aktualisierungen in diesem Handbuch, moechten wir Sie bitten, Kontakt mit der naechsten Strand Lighting-Niederlassung aufzunehmen.

Le matériel décrit dans ce manuel est pour information seulement et est sujet à changements sans préavis. La compagnie Strand Lighting n'assume aucune responsabilité sur toute erreur ou ommission inscrite dans ce manuel. Pour tous commentaires ou suggestions concernant des corrections et/ou les mises à jour de ce manuel, veuillez s'il vous plait contacter le bureau de Strand Lighting le plus proche.

Information contained in this document may not be duplicated in full or in part by any person without prior written approval of Strand Lighting. Its sole purpose is to provide the user with conceptual information on the equipment mentioned. The use of this document for all other purposes is specifically prohibited.

S21™ and eS21™ are trademarks of Strand Lighting,

Document Number: **2-450220-010**

Version as of: **27 April 2010**

S21™ & eS21™ Dimming System Installation & Operation Guide

IMPORTANT INFORMATION

Warnings and Notices

When using electrical equipment, basic safety precautions should always be followed including the following:



- a. **READ AND FOLLOW ALL SAFETY INSTRUCTIONS.**
- b. Do not use outdoors.
- c. Do not mount near gas or electric heaters.
- d. Equipment should be mounted in locations and at heights where it will not readily be subjected to tampering by unauthorized personnel.
- e. The use of accessory equipment not recommended by the manufacturer may cause an unsafe condition.
- f. Do not use this equipment for other than intended use.
- g. Refer service to qualified personnel.

SAVE THESE INSTRUCTIONS.



WARNING: You must have access to a main circuit breaker or other power disconnect device before installing any wiring. Be sure that power is disconnected by removing fuses or turning the main circuit breaker off before installation. Installing the device with power on may expose you to dangerous voltages and damage the device. A qualified electrician must perform this installation.

WARNING: Refer to National Electrical Code® and local codes for cable specifications. Failure to use proper cable can result in damage to equipment or danger to personnel.

WARNING: This equipment is intended for installation in accordance with the National Electric Code® and local regulations. It is also intended for installation in indoor applications only. Before any electrical work is performed, disconnect power at the circuit breaker or remove the fuse to avoid shock or damage to the control. It is recommended that a qualified electrician perform this installation.

CAUTION: Wire openings **MUST** have fittings or lining to protect wires/cables from damage. Use 75° C copper wire only! Aluminum wire may not be used.

Additional Resources for DMX512

For more information on installing DMX512 control systems, the following publication is available for purchase from the United States Institute for Theatre Technology (USITT), "Recommended Practice for DMX512: A Guide for Users and Installers, 2nd edition" (ISBN: 9780955703522). USITT Contact Information:

USITT
6443 Ridings Road
Syracuse, NY 13206-1111 USA
1-800-93USITT
www.usitt.org

TABLE OF CONTENTS

IMPORTANT INFORMATION

Warnings and Notices.....	1
Additional Resources for DMX512.....	1

TABLE OF CONTENTS

PREFACE

About this Guide.....	3
Product Descriptions.....	3
S21™ Dimmer Strips (120V Models).....	3
eS21™ Dimmer Strips (230V/240V Models).....	3

S21™ & eS21™ DIMMER SYSTEM OVERVIEW

S21™ Dimmer Strip Components and Controls (120V Models).....	4
Dimmer Strip Components.....	4
Head-End Processor	4
IGBT Dual 120V, 2.4kW Dimmers	4
eS21™ Dimmer Strip Components and Controls (230V/240V Models).....	5
Dimmer Strip Components.....	5
Head-End Processor	5
IGBT Dual 230V/240V, 2.5kW Dimmers	5
Power Requirements.....	6
S21™ Dimmer Strips (120V).....	6
eS21™ Dimmer Strips (230/240V).....	6
Connecting Power.....	6
Connecting to the DMX512 Network.....	7
Terminating DMX512.....	7
Dimmer Strip Mounting	7

DIMMER SYSTEM FUNDAMENTALS

S21™ & eS21 Dimmer Systems	8
S21™ & eS21™ Dimmer Modules.....	8

HEAD-END PROCESSOR OPERATION AND PROGRAMMING

LCD Menu Operation.....	10
LCD Menu System	10
LCD Menu Structure	11
LCD Display Passwords and Security.....	13
Load Types.....	14
Dimmer Protection.....	15

TECHNICAL SPECIFICATIONS

S21™ Dimmer Strips (120V Models 71500, 71501, and 71502).....	16
eS21™ Dimmer Strips (230V/240V Models 71600, 71601, and 71602).....	16

ACCESSORIES

S21™ Dimmer Strips (120V Models 71500, 71501, and 71502).....	17
Input Power Cables.....	17
Clamps / Mounting / Hangers / DMX512 Termination	17
Spare Modules	17
eS21™ Dimmer Strips (230V/240V Models 71600, 71601, and 71602).....	17
Clamps / Mounting / Hangers / DMX512 Termination	17
Spare Modules	17

PREFACE

1. About this Guide

The document provides installation and operation instructions for the following products:

- S21™ Dimmer Strips (120V) - Models 71500, 71501, and 71502
- eS21™ Dimmer Strips (230V/240V) - Models 71600, 71601, and 71602

Please read all instructions before installing or using this product. *Retain this guide for future reference.* Product information may be downloaded at www.strandlighting.com

2. Product Descriptions

S21™ Dimmer Strips (120V Models)

Part Number	Description
71500	3, Dual 2.4kW (max.) dimmer modules, 1000 μ s transition time, S21™ Dimmer Strip with GP (Grounded Stage Pin) connectors
71501	3, Dual 2.4kW (max.) dimmer modules, 1000 μ s transition time, S21™ Dimmer Strip with GTL (Twistlock) connectors
71502	3, Dual 2.4kW (max.) dimmer modules, 1000 μ s transition time, S21™ Dimmer Strip with GR (Edison, NEMA 5-20R) connectors

Notes:

- (1) Each S21™ IGBT dual module contains two dimmers and is fully rated at 2.4kW per module. The 2.4kW rating of the module may be split evenly across both dimmers at 1.2kW, used on a single dimmer at 2.4kW, or any combination of loads on either dimmer that does not exceed 2.4kw per module.
- (2) S21™ Dimmer Strips do not include optional input power cables which are available for field installation. Optional Power Input cables can be found in "[ACCESSORIES](#)" on page 17.
- (3) Dimmer transition time depends on the selected operating mode. See menu selection for details.

eS21™ Dimmer Strips (230V/240V Models)

Part Number	Description
71600	3, Dual 2.5kW (max.) dimmer modules, 650 μ s transition time, eS21 Dimmer Strip with Powercon connectors & Main Breaker (no load breakers)
71601	3, Dual 2.5kW (max.) dimmer modules, 650 μ s transition time, eS21 Dimmer Strip with CEE17 connectors & Main Breaker (with RCD load breakers)
71602	3, Dual 2.5kW (max.) dimmer modules, 650 μ s transition time, eS21 Dimmer Strip with CEE17 connectors & Main Breaker (no load breakers)

Notes:

- (1) Each eS21™ IGBT dual module contains two dimmers and is fully rated at 2.5kW per module. The 2.5kW rating of the module may be split evenly across both dimmers at 1.25kW, used on a single dimmer at 2.5kW, or any combination of loads on either dimmer that does not exceed 2.5kw per module.
- (2) eS21™ Dimmer Strips do not include input power cables.
- (3) Dimmer transition time depends on the selected operating mode. See menu selection for details.

S21™ & ES21™ DIMMER SYSTEM OVERVIEW

1. S21™ Dimmer Strip Components and Controls (120V Models)

Dimmer Strip Components

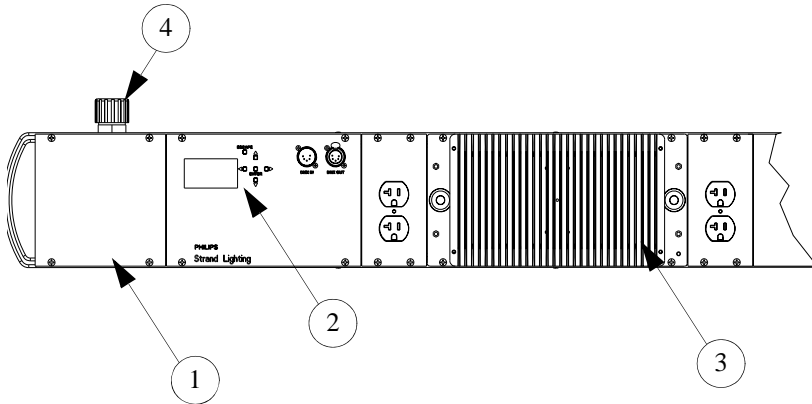

- 1) Field Wiring Compartment
- 2) Head-End Processor
- 3) IGBT Dual 120V, 2.4kW Dimmer (3 each)
- 4) Power Input Strain Relief (shown in one [top] of three position options - top, bottom, or rear)

Head-End Processor

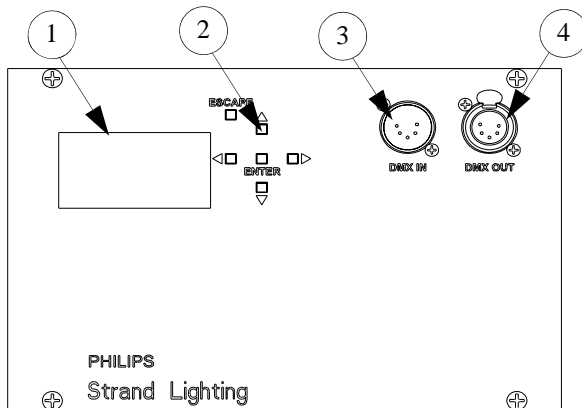

- 1) LCD Display (Menu System)
- 2) Function (Menu System) Select Push Buttons
- 3) DMX512 Input Connector
- 4) DMX512 Pass-Through Connector

IGBT Dual 120V, 2.4kW Dimmers

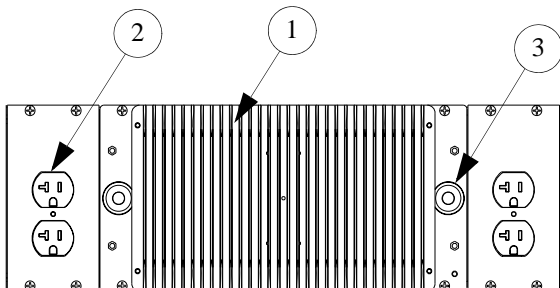

- 1) Dimmer Heatsink
- 2) Load Receptacle (Edison option shown)
- 3) Illuminated Focus Button (one for each dimmer)

2. eS21™ Dimmer Strip Components and Controls (230V/240V Models)

Dimmer Strip Components

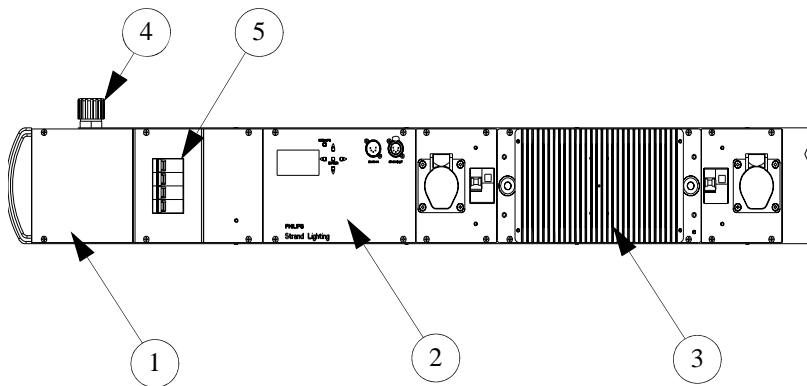

- 1) Field Wiring Compartment
- 2) Head-End Processor
- 3) IGBT Dual 230V/240V, 2.5kW Dimmer (3 each)
- 4) Power Input Strain Relief (shown in one [top] of three position options - top, bottom, or rear)
- 5) Mains Input Breakers

Head-End Processor

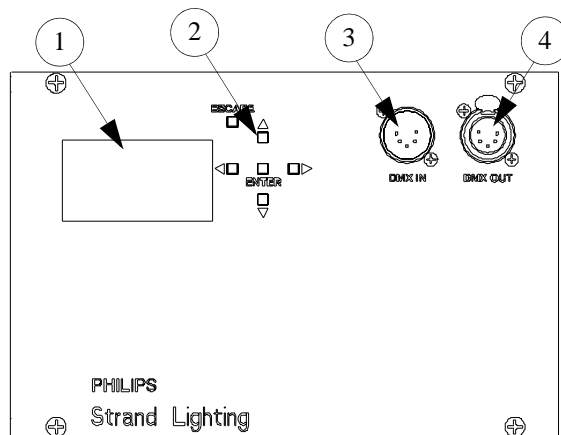

- 1) LCD Display (Menu System)
- 2) Function (Menu System) Select Push Buttons
- 3) DMX512 Input Connector
- 4) DMX512 Pass-Through Connector

IGBT Dual 230V/240V, 2.5kW Dimmers

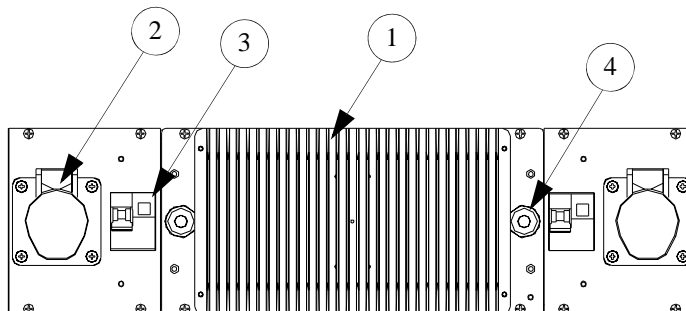

- 1) Dimmer Heatsink
- 2) Load Receptacle (CEE17 option shown)
- 3) Load Breaker (available with CEE17 receptacle option only)
- 4) Illuminated Focus Button (one for each dimmer)

3. Power Requirements

S21™ Dimmer Strips (120V)

S21™ 2400 Watt dimmer systems are designed to operate on a 50 or 60 Hertz, 20 Amp, 120/208 VAC, three phase "WYE" power service. These systems, however, will tolerate a wide variety of input voltages. For them to function normally the Phase to Neutral voltage must be in the range of 90 to 140 VAC.

If a system is mis-wired to voltages greater than 180 VAC, the dimmers will shut down and flash the 'Over Voltage' warning (See "LED Indicators" on page 9). Dimmers will not attempt to bring up loads when in over-voltage shutdown. S21™ is designed to safely tolerate a 230 VAC line indefinitely, and a 280 VAC line for 15 minutes. Line voltages greater than 280 VAC may destroy the over voltage protection components in the dimmers and the Head-End Processor.

eS21™ Dimmer Strips (230/240V)

eS21™ 2500 Watt dimmer systems are designed to operate on a 50 or 60 Hertz, 20 Amp, 230 / 240 VAC, three phase "WYE" power service. These systems, however, will tolerate a wide variety of input voltages. For them to function normally the Phase to Neutral voltage must be in the range of 200 to 260 VAC.

If a system is mis-wired to voltages greater than 230 VAC, the dimmers will shut down and flash the 'Over Voltage' warning (See "LED Indicators" on page 9). Dimmers will not attempt to bring up loads when in over-voltage shutdown. eS21 is designed to safely tolerate a 230 VAC line indefinitely, and a 280 VAC line for 15 minutes. Line voltages greater than 280 VAC may destroy the over voltage protection components in the dimmers and the Head-End Processor.

4. Connecting Power

S21™ Dimmer Strips (120V)

Field wiring of the S21™ dimming system is straight forward. A total of 5 wires need to be brought to the unit: The three "phase" wires (A, B, C), a Neutral, and a Ground. The "phase" wires carry up to 20 amps each, and the Neutral carries the "unbalanced" current. S21™ dimming systems use a NEMA type L21-20 connector. Recommended cable is 10/5 type SO. The wires feeding all dimmers and dimmer outlets are wired in the same order.

The following scheme is suggested:

Connector	Wire	Conductor
"X" or "A"	Black	Phase A
"Y" or "B"	Red	Phase B
"Z" or "C"	Blue or Orange	Phase C
"W" or "N"	White	Neutral
"G"	Green	Earth (Ground)

eS21™ Dimmer Strips (230V/240V)

Field wiring of the eS21™ dimming system is straight forward. A total of 5 wires need to be brought to the unit: The three "phase" wires (L1, L2, L3), a Neutral, and an Earth/Ground. The "phase" wires carry up to 10 amps each, and the Neutral carries the "unbalanced" current. The wires feeding all dimmers and dimmer outlets are wired in the same order.

The following scheme is suggested:

Connector	Wire	Conductor
"X" or "A"	Brown	L1
"Y" or "B"	Black	L2
"Z" or "C"	Gray	L3
"W" or "N"	Blue	Neutral
"G"	Green/Yellow	Earth (Ground)

5. Connecting to the DMX512 Network

Basic DMX512 installation consists of Connecting S21™ or eS21™ dimmer strips together in "daisy-chain" fashion. A cable runs from the control console to the "DMX IN" connector on the first S21™ or eS21™ dimmer strip. Another cable runs from the "DMX OUT" connector on the first unit to the "DMX IN" connector on the second dimmer strip. All units are connected together in this fashion. Do not exceed DMX512 cable length, number of maximum receivers, or termination rules. For more information on DMX512, please refer to ["Additional Resources for DMX512"](#) on page 1.

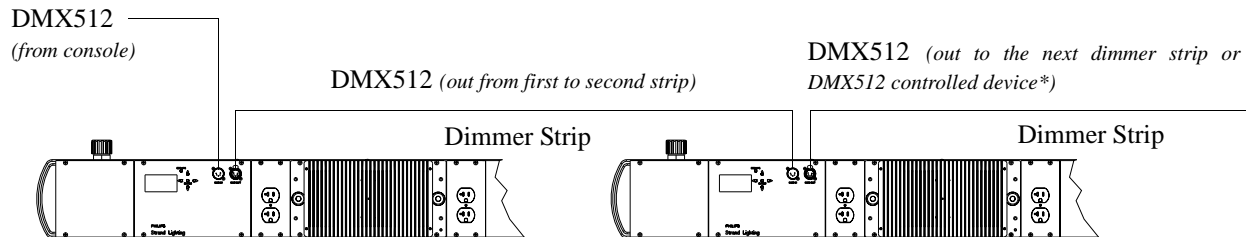

DMX512 Connections	
DMX512 Signal	XLR Pin Number
Common (Drain)	1
DMX512 -	2
DMX512 +	3
TALK -	4
TALK +	5

Note: * If there are no other DMX512 devices connected to the dimmer strip, then the dimmer strip must be terminated (see ["Terminating DMX512"](#)).

Terminating DMX512

If a unit has cable plugged into its "DMX OUT" connector which runs to another S21™ or eS21™ dimmer strip or other DMX512 device, a DMX512 terminator is not required on the dimmer strip.

If a unit does not have a cable plugged into its "DMX OUT" connector, the dimmer strip must be terminated by a five-pin DMX512 termination plug (Strand Lighting part number 71346 or equivalent).

DMX512 Termination Plug

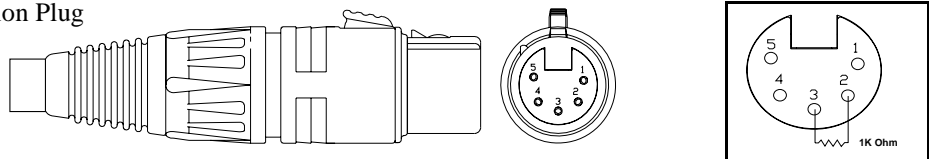

For more information on DMX512 networking and systems, refer to ["Additional Resources for DMX512"](#) on page 1.

6. Dimmer Strip Mounting

There are several ways to mount S21™ or eS21™ dimmer strips. Below are the mounting brackets available from Strand Lighting. Refer to ["ACCESSORIES"](#) on page 17 for ordering information. Refer to each bracket's installation instructions for specific installation information. Note, all brackets and clamps are sold separately.

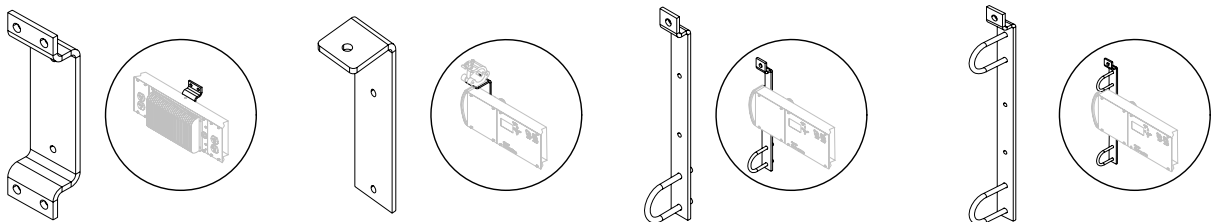

Wall Mount Bracket

Pipe Mount Bracket*

Single Pipe Mount Hanging Bracket

Double Pipe Mount Hanging Bracket

*For use with cheeseboro, pipe or hook clamps (all clamps are sold separately).

DIMMER SYSTEM FUNDAMENTALS

1. S21™ & eS21 Dimmer Systems

The S21™ & eS21™ dimmers are multi-mode units that automatically analyzes its connected load and picks the most appropriate dimming technique. Depending on the load, the dimmer will use either Reverse Phase Control (RPC) or Forward Phase Control (FPC). Whenever possible, the dimmer will choose RPC because of the advantages it offers in terms of reduced lamp noise and increased regulation accuracy. Both techniques control the average power applied to the load by limiting current flow to only certain portions of each power line half cycle.

Forward Phase Control

Forward Phase Control is the technique used by all previous electronic dimmers, although earlier implementations have been far less sophisticated than S21™ or eS21™ dimmers. This scheme only allows current to flow during the latter portion of each half cycle. As the relative duration of the conducting portion is increased, so is the average power applied to the load, and hence its brightness.

Reverse Phase Control

Reverse Phase Control, on the other hand, limits current flow to the early portions of each half cycle. The dimmer monitors the power applied to the load in real time during the half cycle and adjusts its switch-off point as needed to regulate the light output.

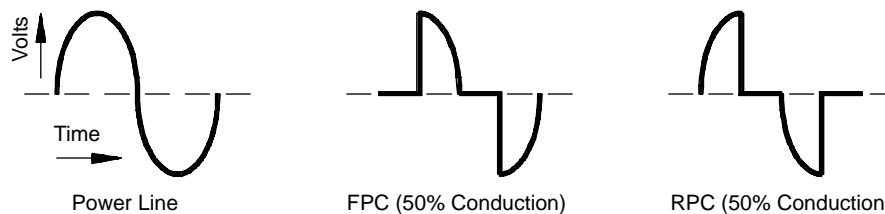

When switching-off the output in each half cycle, it is important to control the slope of the falling wave form so as to minimize the acoustic noise made by the lamp filament, and the radio frequency noise radiated by the dimmer. Previous dimming technologies accomplished this by placing a large coil of wire in series with the output of the dimmer. The unique power stage in S21™ & eS21™ dimmers allows this function to be performed directly in the dimmer. By stretching this fall time out to 400 or even 1000 μ S, S21™ dimmers (400 or even 650 μ S for eS21™ dimmers) achieve exceptionally quiet operation without high insertion losses, and without the line distortion caused by inductors.

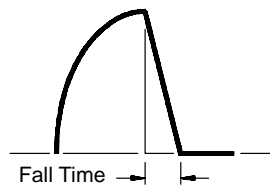

Note: Some manufacturers sometimes refer to "Forward Phase Control" as "Leading Edge" and "Reverse Phase Control" as "Trailing Edge."

2. S21™ & eS21™ Dimmer Modules

Each S21™ and eS21™ Dimmer Module contains a dual dimmer assembly (2.4kW for S21™ dimmer strips and 2.5kW for eS21™ dimmer strips) with power shared between the two dimmers within the module. Each dual dimmer

module includes two Focus/LED Indicator buttons, that functions as both focus adjustment control and status indicator for its dimmer.

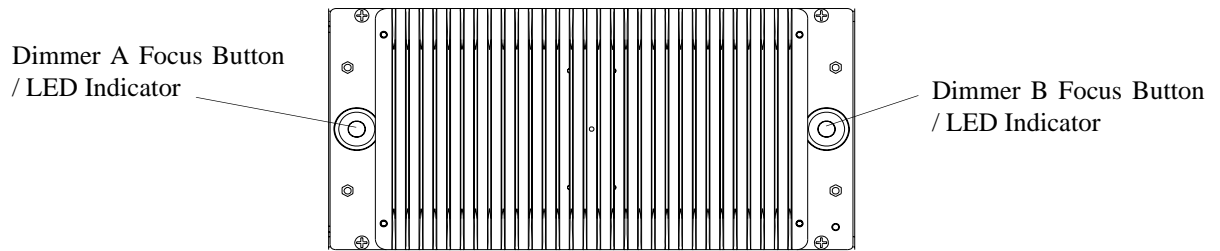

Focus Buttons

The Focus Buttons can be used to quickly set the output level or test the module as follows:

- If the module is Off, a tap on the button will take it to full on.
- If the module is On, a tap will turn it off.
- Whether On or Off, pressing and holding the button will ramp up the intensity level. Releasing the button will hold the setting at an intermediate level.

Note: Fixtures turned on by the Focus Button will remain on until a control console sets a non-zero DMX512 level for the module. The module's level setting will be cancelled and it will now follow console control. If the module is already set to a non-zero DMX512 level by the console, the button becomes a "Flash-to-Full" control, overriding the level only while the button is pressed.

LED Indicators

The two LEDs associated with each dimmer report various operating conditions. The Red LED turns on for approximately 4 seconds on power-up, and after that the indications are as follows:

Red LED	Green LED	Condition
Off	Off	Normal
Off	Flashing	No Load
Off	On	Focus Mode (controlled at dimmer)
Flashing (1.5 sec On, 0.5 sec Off)	Off	Oversized Load or Overload
Flashing (0.5 sec On, 0.5 sec Off)	Off	Over Operational Temperature
On	Off	No Communications with Head-End Processor
Flashing	Flashing	Over Voltage

HEAD-END PROCESSOR OPERATION AND PROGRAMMING

1. LCD Menu Operation

The Head-End Processor’s LCD Display and Menu System provides local control for accessing all system status information and for making configuration changes to the particular dimmer strip. (If there are multiple dimmer strips in the system, changes would need to be made at each LCD Menu.)

Upon power up, the LCD Menu will display the Philips logo. After power up, one of the following will happen - the MAIN MENU will appear (if password protection is not set) OR if password protection is set, a screen with dimmer name and lock symbol will appear. Note, DMX512 Address will be shown if set to display on main screen.

Note: To return to the power up screen after boot up, press the [Escape] button.

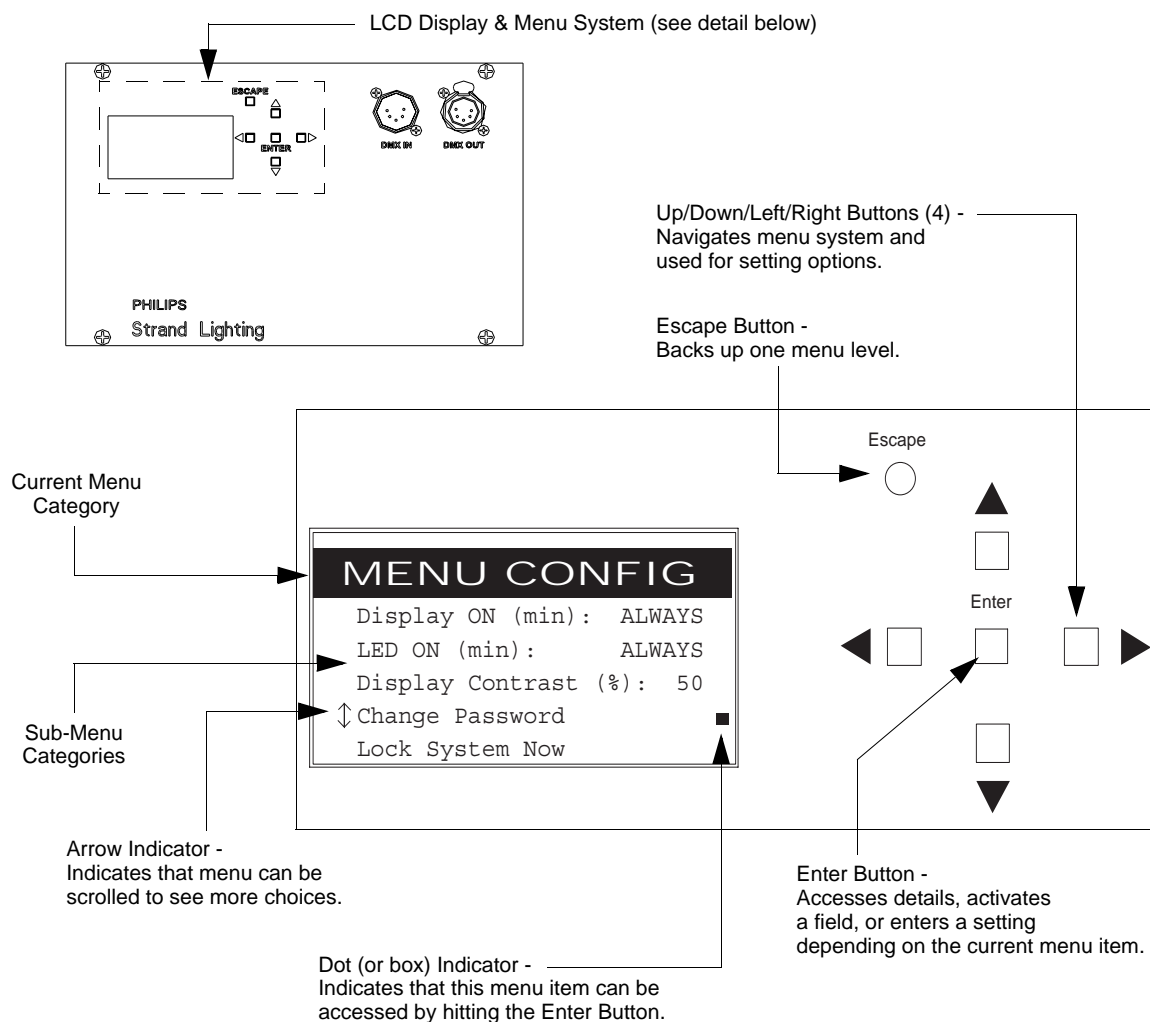

Figure 2-1: LCD Display and Menu System

2. LCD Menu System

The Head-End Processor LCD Display Menu system consists of several main categories. To navigate the menus, press the four navigation buttons as required (**Figure 2-1**). When the desired menu is reached, press [Enter] to display the menu options. Use navigation and [Enter] buttons to view status and configure the LCD Menu as required.

LCD Menu Structure

MAIN MENU

- Dimmer Start Address (DMX ADDRESS)
- System Status (SYSTEM STATUS)
- Dimmer Status (DIMMER STATUS)
- Dimmer Options Config (DIMMER OPTIONS)
- System Configuration (SYSTEM CONFIG)
- Edit Local Presets (EDIT PRESETS)
- Menu Configuration (MENU CONFIG)

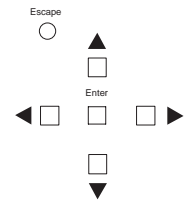
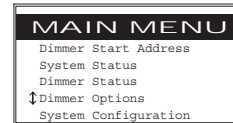

DMX ADDRESS

Sub Menu	Options	Comments
DMX Start Address	Sets DMX512 address (XXX)	Left and Right keys for -10 or +10 / Up and Down keys for +1 or -1 for addressing
Show On Main Screen?	Yes or No	Selects to display DMX512 address on main screen

SYSTEM STATUS (status information shown, no user-selectable options)

Sub Menu	Options	Comments
Type	N/A	Displays dimmer type (will be Dimmer Strip)
Dimmer Status	N/A	Displays either OK (no errors) or Errors
Dimmer Present	N/A	Displays the number of dimmers in the dimmer strip
Dimmers with Errors	N/A	Displays the number of dimmers with errors
Firmware	N/A	Displays head-End Processor current firmware version as, "86-XXXX vX.XX)

DIMMER STATUS (status information shown, no user-selectable options)

Sub Menu	Options	Comments
Slot	N/A	Displays dimmer information being viewed (and its DMX512 address)
Level	N/A	Displays dimmer's current operational level (in percentage)
TMP	N/A	Displays current temperature of dimmer (displayed in both C and F)
Line	N/A	Displays input line voltage (in VAC)
Load	N/A	Displays connected load to dimmer (displayed in watts)
Status	N/A	Status of dimmer Normal, Non-Dim, or Breaker Off? (if no power to dimmer)
Errors	N/A	Displays if the dimmer is experiencing any errors

Continued next page

LCD Menu Structure (continued)

Continued from previous page

DIMMER OPTIONS

Sub Menu	Options	Comments
Slot	N/A	Displays dimmer (1 through X) for the dimmer to be configured (and its DMX512 address)
Mode	RPC (Reverse Phase Control) / FPC (Forward Phase Control) / Non-Dim / LED	Sets dimmer operation. Also allows user to set the dimmer to Non-Dim operation (as a On or Off device). LED mode is for line voltage LED fixtures that require locked reverse phase control dimming (set at 400µS).
Non-Dim%	0 to 100%	When dimmer is in non-dim mode, this option sets the dimmer's threshold level (selection 0 to 100%). Levels below this will turn the dimmer off and levels equal to or above this percentage will turn them on
Voltage at Full (VAC)	100 / 110 / 115 / 120 VAC (S21™ dimmer strips only)	Sets dimmer operational voltage. Using a voltage lower than lamp specification can prolong lamp life
	200 / 220 / 230 / 240 VAC (eS21™ dimmer strips only)	
Transition (µS) (in microseconds)	400 / AUTO*	Options available (in both FPC and RPC) are either 400µS (set) or AUTO (automatically adjusts between 400µS to 1000µS for S21 dimmer and 400µS to 650µS for eS21 dimmers).
	*Note, when "LED" option is selected in "Mode", the dimmer is set to 400 µS and cannot be changed to AUTO.	
Dimmer Curve	Linear / Square Law / Invert / Slow Bottom / Fast Bottom / Fast Top / Full at 1 / Out at 100 / Preheat 5% / Preheat 10% / Hot Patch / Adv Mark 10 (Advance Mark 10 fluorescent ballasts)	Sets dimmer curve (dimming operation) for each dimmer in the dimmer strip
Preheat	Yes / No	Allows dimmer to be set to preheat mode. Normally preheat mode is used to "speed up" large wattage lamps so they behave more like smaller ones

SYSTEM CONFIG

Sub Menu	Options	Comments
DMX Hold (hh:mm) (in hours:mins)	None / 0:01 / 0:05 / 0:10 / 0:15 / 1:00 / 2:00 / 4:00 / 12:00 / 24:00	Sets the amount of time the dimmer strip will keep and adhere to the last DMX512 levels
Power-up Preset	None / 1 / 2 / 3 / 4 / 5 / 6 / 7 / 8	Sets what preset the dimmers go to when dimmer strip is initially powered
Power-up Hold	Forever / 0:01 / 0:05 / 0:10 / 0:15 / 1:00 / 2:00 / 4:00 / 12:00 / 24:00	Sets the amount of time the dimmers will go and stay at the preset level (if set) when the dimmer strip is initially powered. Will follow DMX512 commands at anytime
DMX Clears Preset	Yes / No	Sets how Presets are cleared either never or via DMX512

SELECT PRESET

Sub Menu	Options	Comments
Select a Preset	None / 1 / 2 / 3 / 4 / 5 / 6 / 7 / 8	Manually selects a preset via the Head-End Processor (as in testing processor communication and dimmer operation)

Continued next page

LCD Menu Structure (continued)

Continued from previous page

EDIT PRESETS

Sub Menu	Options	Comments
Slot	N/A	Displays dimmer (1 through X) for the dimmer to be configured (and its DMX512 address)
Preset	1 / 2 / 3 / 4 / 5 / 6 / 7 / 8	Selects the preset to be programmed
Level (%)	0 to 100% (in 1% increments)	Selects the preset level of the dimmers (each dimmer is individually programmable)
Dimmer Set	One / All / Capture (Yes / No)* * Next selection is "Capture ALL Dimmers? (Yes / No)	Allows users to set preset to one or all dimmers (at the same time) or Capture (snapshot) a look from all dimmers

MENU CONFIG

Sub Menu	Options	Comments
Backlight On (min) (in minutes)	Always (always on) / 0 to 60 minutes (in 1 minute increments)	Sets the amount of time the Head-End Processor LCD Display backlight is on after last button press
Display Contrast	0 to 100% (in 1% increments)	Allows user to set the contrast level of the LCD Display
Set New Password	# # # #	Each "#" can be set from 0 to 9 (numeric only) to establish a four-digit password. For more information, see "LCD Display Passwords and Security" below.
* Change Password	# # # #	Each "#" can be set from 0 to 9 (numeric only) to establish a new four-digit password. Note, you must enter old password first to get to this section.
* Lock System Now	Hit [Enter] to force system lock	After locking system, a lock symbol will appear on the LCD display.

* These options appear when a password is established. "Change Password" replaces "Set New Password" in MENU CONFIG screen.

LCD Display Passwords and Security

Setting a password and locking the LCD menus prevents unwanted changes to system or dimmer operational settings. Status information (of the dimmer strip system and individual dimmers) can still be viewed through the menu status screens.

S21™ and eS21™ dimmer strips are shipped without an established password. Users must set their own password (four-digit number) before the LCD menu options can be locked. When setting a password, write it down and keep it in a secure location. Note, Strand Lighting does not have records of passwords established by users or owners.

Setting a Password

- Step 1. From LCD Display MAIN MENU, scroll to MENU CONFIGURATION (MENU CONFIG) screen.
- Step 2. At MENU CONFIG, select "Set New Password"
- Step 3. Using Up [▲] / Down [▼] / Left [◀] / Right [▶] arrow buttons, set each "#" to establish a four-digit password.
- Step 4. When each "#" sign has been assigned a number, hit [Enter] (center button on display). If you hit [ESC] (Escape) password will not be stored and process must be repeated.
- Step 5. Password is set. After 15 minutes of inactivity (no menu button presses), the LCD menu will go into locked mode (changes cannot be made to menu options unless the password is entered).

Step 6. To force the LCD Display into lock mode, please see "[Lock System Now \(forcing the LCD menus into lock mode\)](#)".

Changing a Password

- Step 1. From LCD Display MAIN MENU, scroll to MENU CONFIGURATION (MENU CONFIG) screen. If system is locked, you will have to enter current password.
- Step 2. At MENU CONFIG, select "Change Password"
- Step 3. Using Up [▲] / Down [▼] / Left [◀] / Right [▶] arrow buttons, set each "#" to establish a four-digit password.
- Step 4. When each "#" sign has been assigned a number, hit [Enter] (center button on display). If you hit [ESC] (Escape) password will not be stored and process must be repeated.
- Step 5. Password is set. After 15 minutes of inactivity (no menu button presses), the LCD menu will go into locked mode (note, changes cannot be made to menu settings unless the password is entered. System and dimmer status can be viewed in locked mode).
- Step 6. To force the LCD Display into lock mode, please see "[Lock System Now \(forcing the LCD menus into lock mode\)](#)".

Lock System Now (forcing the LCD menus into lock mode)

Note: Before the LCD menus can be locked, a password must be established by user. If a password has not been set, see "[Setting a Password](#)".

- Step 1. From LCD Display MAIN MENU, scroll to MENU CONFIGURATION (MENU CONFIG) screen.
- Step 2. At MENU CONFIG, select "Lock System Now" and hit [Enter] on menu.
- Step 3. System is locked. A lock symbol will be displayed on the main screen to show LCD Display is locked (note, changes cannot be made to menu settings unless the password is entered. System and dimmer status can be viewed in locked mode).

3. Load Types

General

S21™ dimmers are designed to operate a wide variety of lighting loads of up to their rated capacity. The range of load types which may be connected includes incandescent lamps, and a number of "well-behaved" inductive loads such as low-voltage (step-down transformer) fixtures, fluorescent lamps, and most types of small motors used in special effects equipment such as wind or fog machines.

WARNING! S21™ and eS21™ dimmers are not designed to drive large motor loads (3 Amps or greater), or motors with start-up capacitors. Attempting to drive such loads may damage the dimming electronics or dimmer.

Low-Voltage Fixtures

When operating low-voltage type fixtures, observe the following precautions: If the fixture has a conventional magnetic transformer, be sure it has internal fusing and is approved for dimming by its manufacturer. Load the dimmer to only 80% of its capacity (i.e., 960VA for a 1.2KW dimmer) to compensate for losses in the transformer. If the fixture has an "electronic transformer", make sure it is approved for dimming by its manufacturer.

Neon Fixtures

Neon fixtures and signs can be particularly difficult to dim as they tend to reflect back nearly all of the energy which is applied to them. For best results with neon, a dimmer should be loaded to no more than 50% of its capacity (i.e., 600VA for a 1.2KW dimmer), should be configured for Forward Phase Control operation, and should have an incandescent load of 100 to 200 watts added to help absorb the reflected energy. Failure to take these precautions may result in damage to the dimming electronics or dimmer.

Also, for best results, increase the neon transformer voltage 50% over the normal requirements for the selected length and diameter of the tube. Use only Low Power Factor (without power factor compensation), current limiting, high-voltage transformers. Mount the transformer with the lamp it operates. This will increase lamp stability and dimming range. Neon tubes must be pumped for a hard vacuum to minimize impurities in the lamp to insure flicker-free operation at low light levels.

LED Line-Voltage Fixtures

S21™ and eS21™ dimmer strips offer a dedicated dimming option for line-voltage LED fixtures. LED fixtures that require a locked reverse-phase control dimming curve is available through the LCD menu system. Refer to ["DIMMER OPTIONS" on page 12](#) on how to set a dimmer to the LED dimming mode.

Non-Dim Operation

When set for Non-dim operation, the S21™ and eS21™ dimmers bypass the dimming modes mentioned above, and simply switches into full conduction. Normal overload protection is still active, but the dimmer does not attempt to regulate its output voltage. Non-dim mode is intended to control small motors and fans such as those found in color scrollers and scenic projectors.

WARNING! S21™ and eS21™ dimmers, in non-dim mode, are not designed to run automated luminaires, large loads, or flash pots. Damage to the dimmer or attached equipment may occur.

4. Dimmer Protection

S21™ and eS21™ dimmer can detect an overload in several ways:

- 1) By calculating the load size from the measured voltage and current. This protects the dimmer from mis-sized loads, such as connecting more than its rated wattage to a single dual dimmer module.
- 2) By the hardware current limiter shutting down the dimmers output. This protects the dimmer from catastrophic faults like short circuits.

The Over-sized load threshold is about 35% above the nominal dimmer capacity. This gives enough latitude for lamp manufacturing tolerances and load shift with temperature, yet still protects the dimmer from gross loading errors.

Once an overload has been detected, the dimmer spends about 5 seconds monitoring the load before deciding to shut down. If the hardware current limit caused the fault, the load is monitored at extremely low voltages. If the fault has not cleared at the end of this time, the dimmer shuts down and reports the error. Depending on the cause, the Status Monitor will show either "Over-sized Load", or "Overload".

The load must be reduced to the correct size and the level must be reset to zero before the dimmer will resume normal operation.

Optional Load-Side Breakers (eS21™ dimmer strips only)

eS21™ dimmer strips are available with optional RCD breakers installed on the load side of the dimmer. Refer to ["eS21™ Dimmer Strip Components and Controls \(230V/240V Models\)" on page 5](#) for more information.

Thermal Protection

The portion of the S21™ and eS21™ dimmer output wave form which generates the most heat is the transition from on to off (off to on for FPC). This portion is known as the transition time, and its duration directly affects the amount of heat generated. The S21™ dimmer can control the duration of this portion of its output wave form and thus, to a certain degree, its operating temperature.

If the dimmer is in its normal operating temperature range, it will use the longest transition time available (up to 1000µs for S21™ dimmers and up to 650µs for eS21™ dimmers). Should its operating temperature reach 85° C (likely only if the ambient temperature is very high), it will automatically select a shorter transition time to reduce the amount of heat generated. In many cases this will be sufficient to stabilize the temperature. Should the temperature continue to rise, and reach 95° C, the dimmer will completely shut down to prevent an over temperature failure. After an over temperature shut-down the temperature must drop to 50° C and the level must be reset to zero to resume normal operation.

TECHNICAL SPECIFICATIONS

1. S21™ Dimmer Strips (120V Models 71500, 71501, and 71502)

Number of Dimmers:	3 Dual Dimmer Modules
Output Voltage:	100V / 110V / 115V / 120V (user selectable)
Minimum Load:	1 watt
Maximum Load/Dimmer:	2.4kW per Dimmer Module (max.)
Dimming Phase:	Forward or Reverse (user selectable or automatic)
Transition (Rise) Time:	Up to 1000 μ S (automatic adjustable)
Insert Loss:	Max 2.5 volts
Power Feed:	3-phase 4 wire 120/208 volts 20 amps; Terminal block or optional input power cables available
Frequency:	50/60Hz
Ambient Temperature:	0 to 40 degrees C
Humidity:	5%-95% Non condensing
Cooling:	Natural Convection
Height:	6.0 in. (152.4 mm)
Depth:	4.0 in. (101.6 mm)
Length:	72.0 in. (1,828.8 mm)
Weight:	38.5 lbs (17.5 kg)
Load Connector Types:	GP – Grounded Stage Pin GTL – Twistlock GR – Edison NEMA 5-20R
Compliance:	ETL Listed



2. eS21™ Dimmer Strips (230V/240V Models 71600, 71601, and 71602)

Number of Dimmers:	3 Dual Dimmer Modules
Output Voltage:	200V / 220V / 230V / 240V (user selectable)
Minimum Load:	1 watt
Maximum Load/Dimmer:	2.5kW per Dimmer Module (max.)
Dimming Phase:	Forward or Reverse (user selectable or automatic)
Transition (Rise) Time:	Up to 650 μ S (automatic adjustable)
Insert Loss:	Max 2.5 volts
Power Feed:	3-phase 4 wire 240 / 420 volts ("WYE" power service) 10 amps; Terminal block.
Frequency:	50/60Hz
Ambient Temperature:	0 to 40 degrees C
Humidity:	5%-95% Non condensing
Cooling:	Natural Convection
Height:	152.4 mm
Depth:	101.6 mm
Length:	2,286.0 mm
Weight:	20.4 kgs
Load Connector Types:	Powercon or CEE17
Compliance:	CE Marked



ACCESSORIES

Contact your Authorized Strand Lighting Dealer for price and availability of all accessories for S21™ and eS21™ dimmer strips. Additional information can be found on the Strand Lighting web site at www.strandlighting.com.

1. S21™ Dimmer Strips (120V Models 71500, 71501, and 71502)

Input Power Cables

Part Number	Description
71432	6 ft AWG #10/5 power input cable with L21-20P GTL plug for field installation
71436	6 ft AWG #10/5 power extension cable with L21-20P GTL plugs
71437	8 ft AWG #10/5 power extension cable with L21-20P GTL plugs
71438	12 ft AWG #10/5 power extension cable with L21-20P GTL plugs

Clamps / Mounting / Hangers / DMX512 Termination

Part Number	Description
USCLAMP	Pipe Clamp
71351	Cheeseboro Clamp
71725	Pipe Mount Bracket (for use with Cheeseboro or Pipe Clamps)
71727	Wall Mount Bracket
71730	Single Pipe Mount Hanging Bracket
71731	Double Pipe Mount Hanging Bracket
71346	DMX512 Terminator

Spare Modules

Part Number	Description
71700	Spare 120V Dual Dimmer Module
71701	Spare Processor / LCD Display Unit

2. eS21™ Dimmer Strips (230V/240V Models 71600, 71601, and 71602)

Clamps / Mounting / Hangers / DMX512 Termination

Part Number	Description
71729	Hook Clamp
71351	Cheeseboro Clamp
71726	Pipe Mount Bracket (for use with Cheeseboro or Pipe Clamps)
71728	Wall Mount Bracket (metric)
71732	Single Pipe Mount Hanging Bracket
71733	Double Pipe Mount Hanging Bracket
71346	DMX512 Terminator

Spare Modules

Part Number	Description
71700	Spare 230V/240V Dual Dimmer Module
71701	Spare Processor / LCD Display Unit



Strand Lighting
Dallas
10911 Petal Street
Dallas, TX 75238
Tel: 214-647-7880
Fax: 214-647-8030

Strand Lighting
New York
267 5th Ave, 4th Floor
New York, NY 10016
Tel: 212-213-8219
Fax: 212-532-2593

Strand Lighting Asia Limited
Room 6-10,
20/F Delta House 3 On Yiu Street
Shatin, N.T. Hong Kong
Tel: + 852 2757 3033
Fax: + 852 2757 1767

Strand Selecon
Auckland
19-21 Kawana Street
Northcote, Auckland 0627
New Zealand
Tel: +64 9 481 0100
Fax: +64 9 481 0101

Strand Lighting
Europe
Marssteden 152
Enschede 7547 TD
The Netherlands
Tel: +31 53 4500424
Fax: +31 53 4500425

www.strandlighting.com