

4

1

3

2

1

D

C

B

A

D

C

B

A

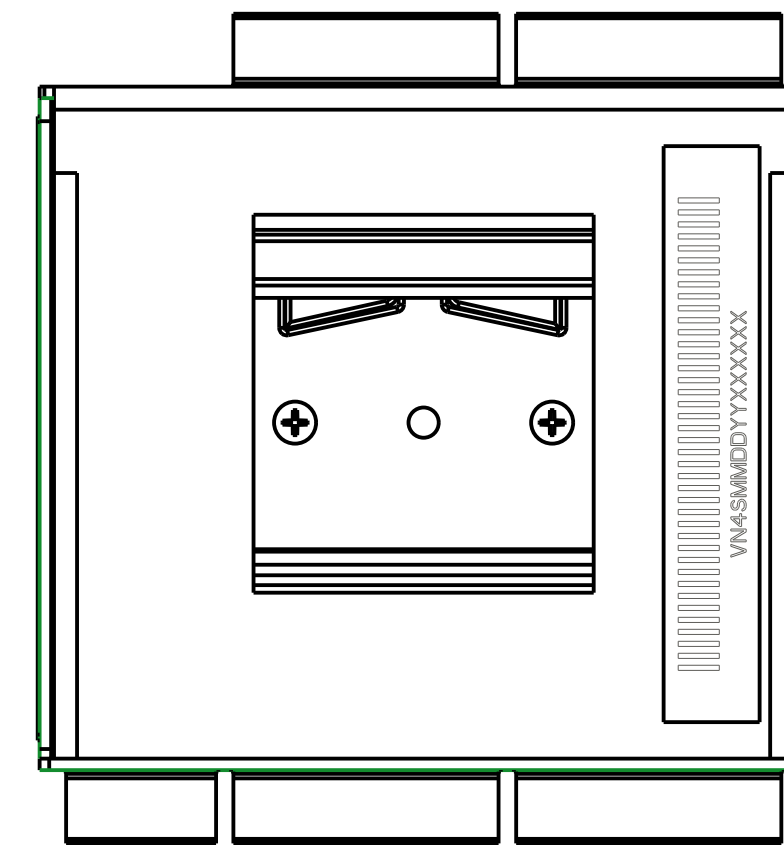
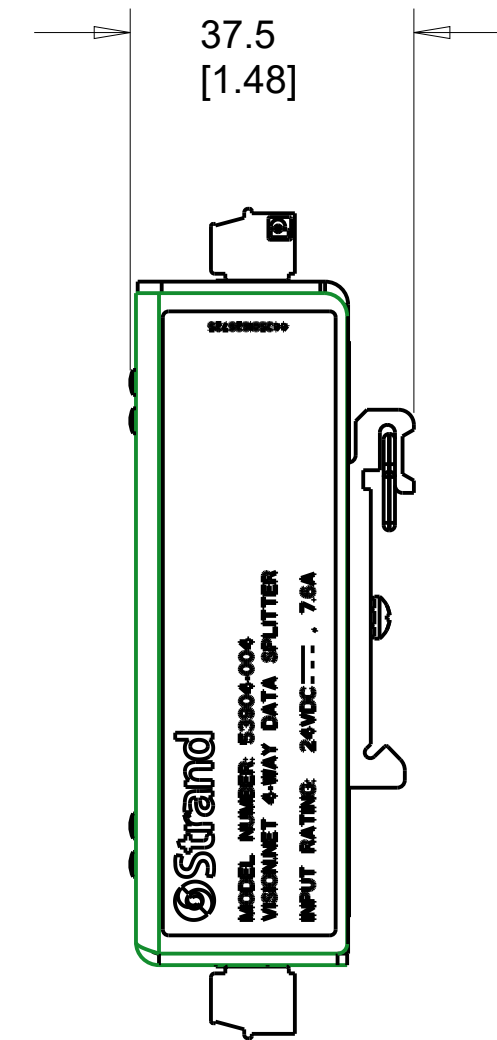
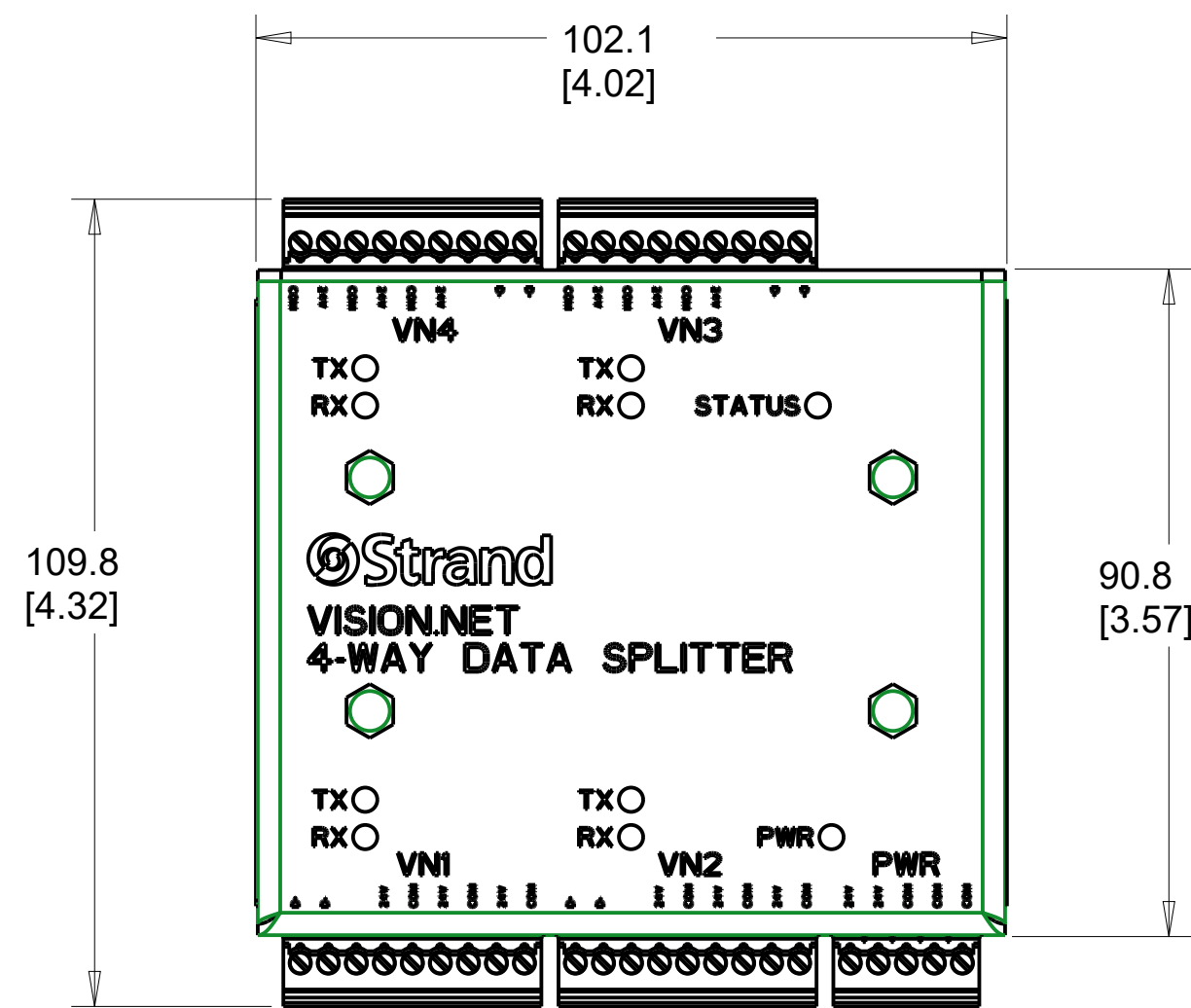
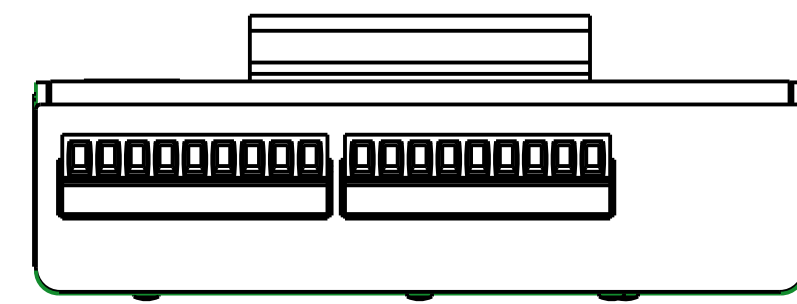

DIN RAIL MOUNT CONFIGURATION (AS SHIPPED)

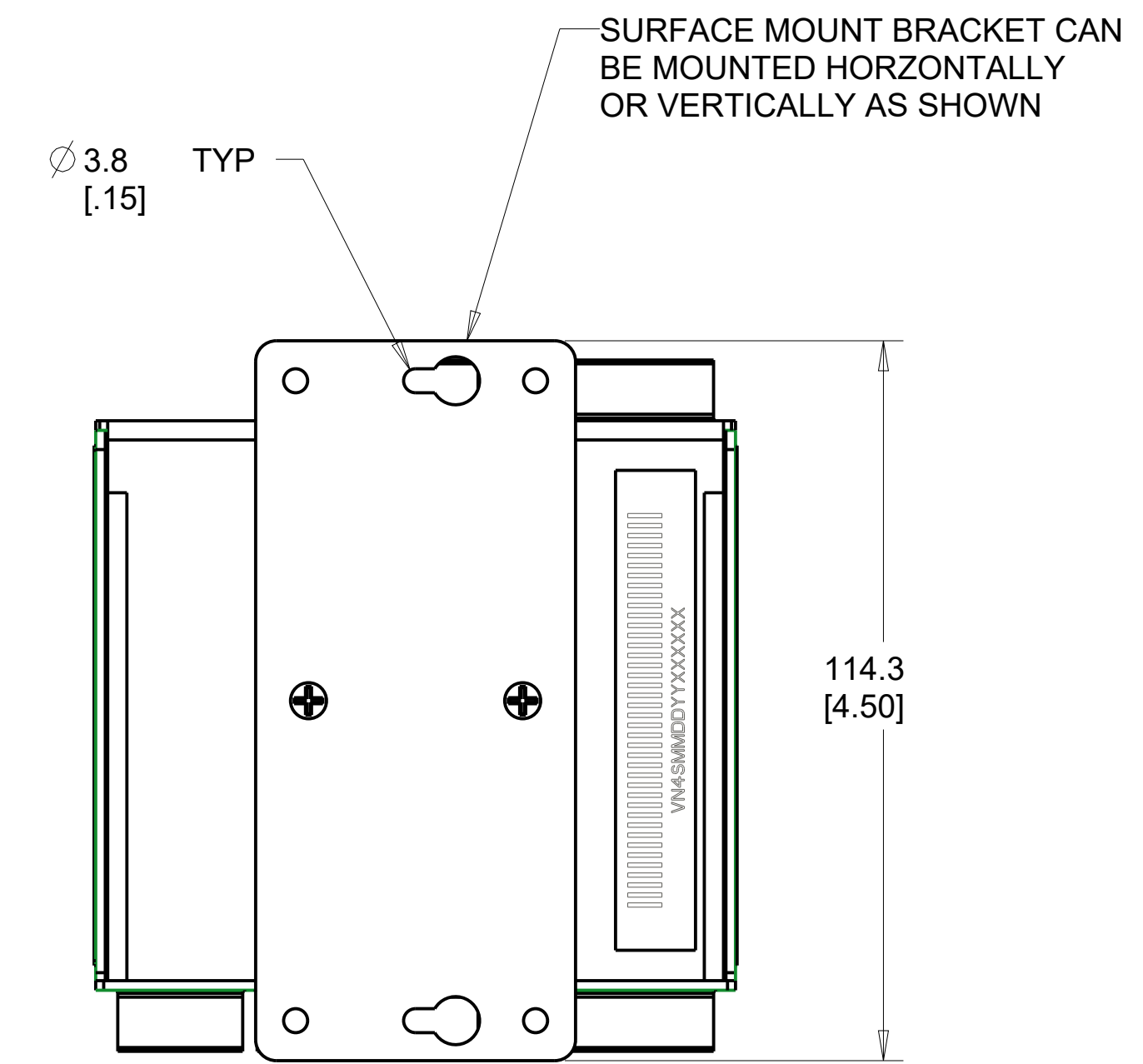

SURFACE MOUNT CONFIGURATION

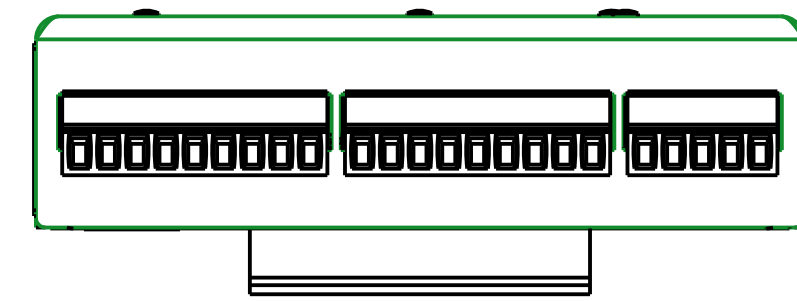
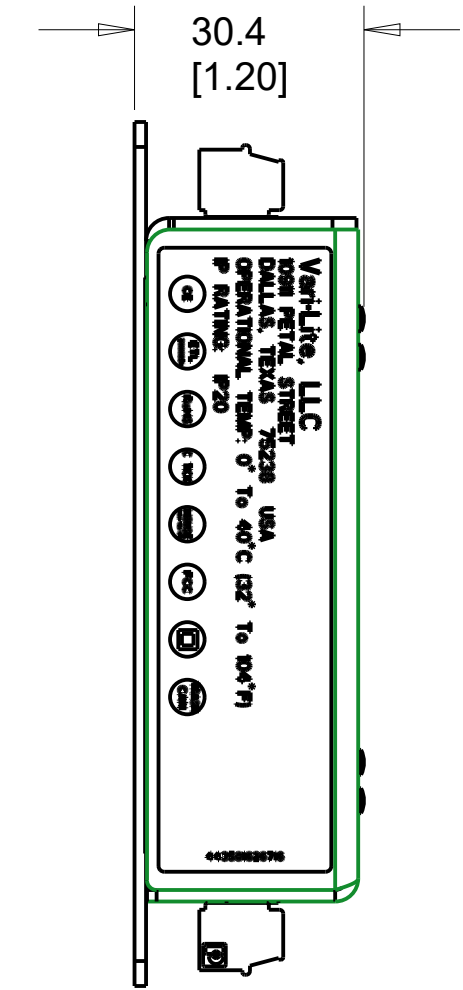

NOTES:
 1. DIMENSION UNITS ARE MM/[IN].
 2. MOUNTS TO STANDARD TS35/7.5 DIN RAIL AND UTILIZES 6 SU.
 3. ALLOW ROOM ABOVE AND BELOW THE UNIT WHEN MOUNTING FOR CABLE/WIRE ROUTING.

		VISION.NET 4-WAY SPLITTER OUTLINE DIMENSION DRAWING			
Vari-Lite, LLC 10911 PETAL ST. DALLAS, TX 75238		DATE 2/21	SIZE D	REVISION A	DRAWING NUMBER 53904-004
© 2020 SIGNIFY HOLDING. ALL RIGHTS RESERVED		SCALE 1.00	CREO 3.0	SHEET 1	OF 1