

4

1

3

2

1

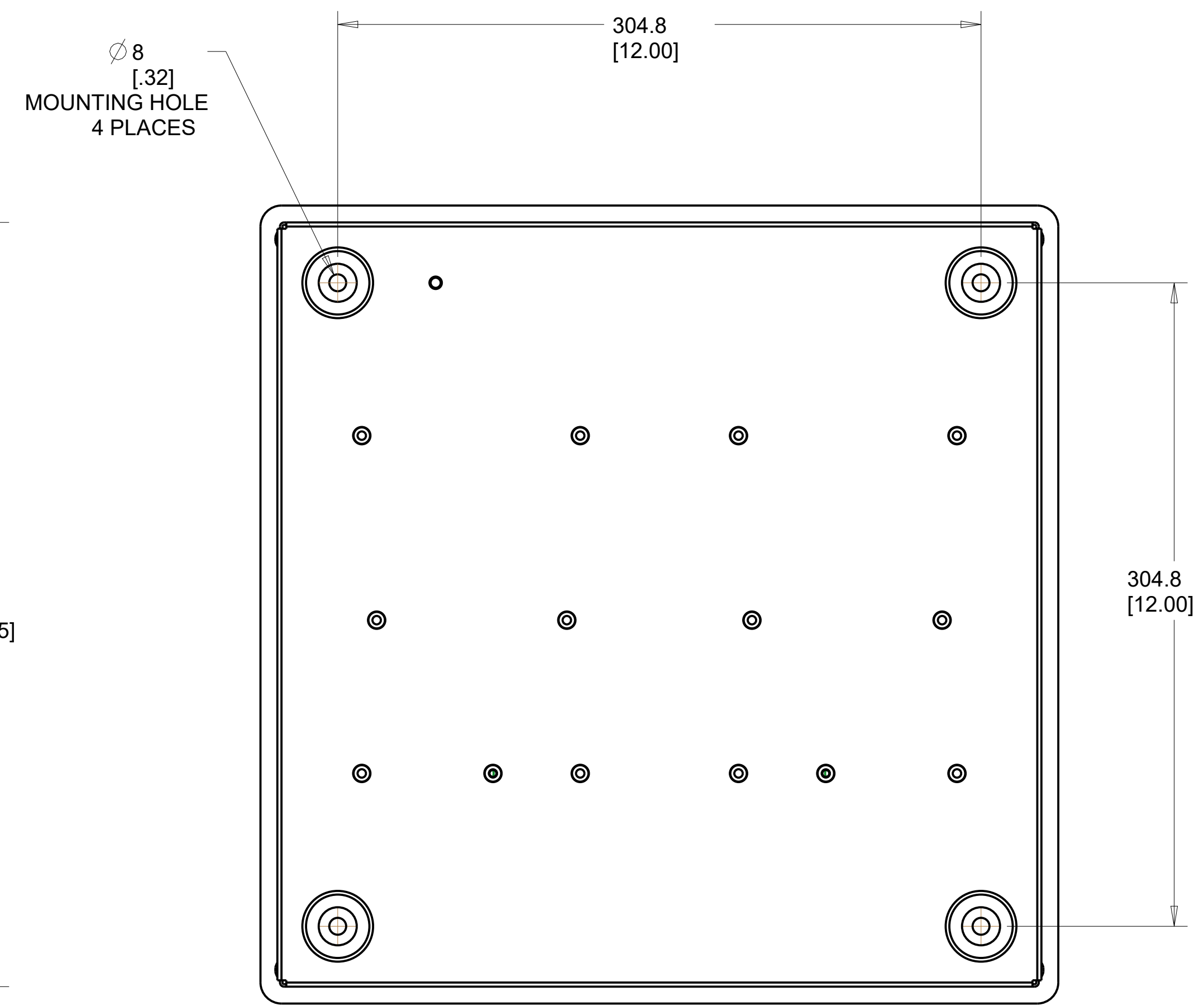
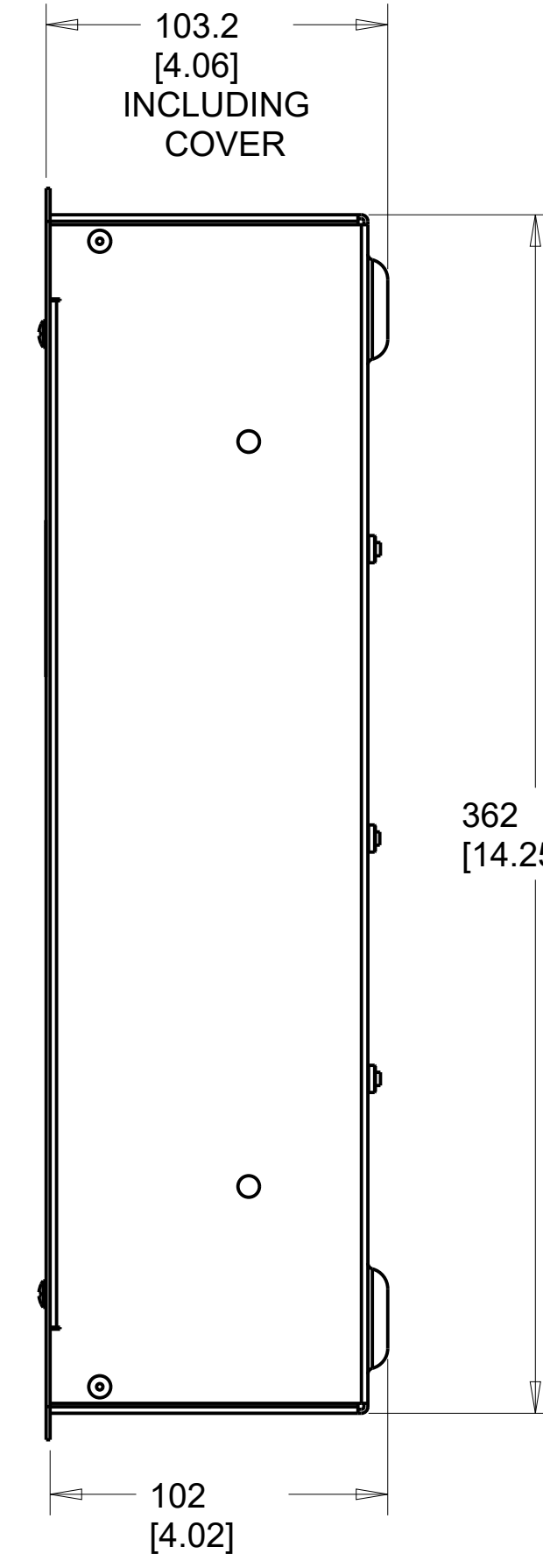
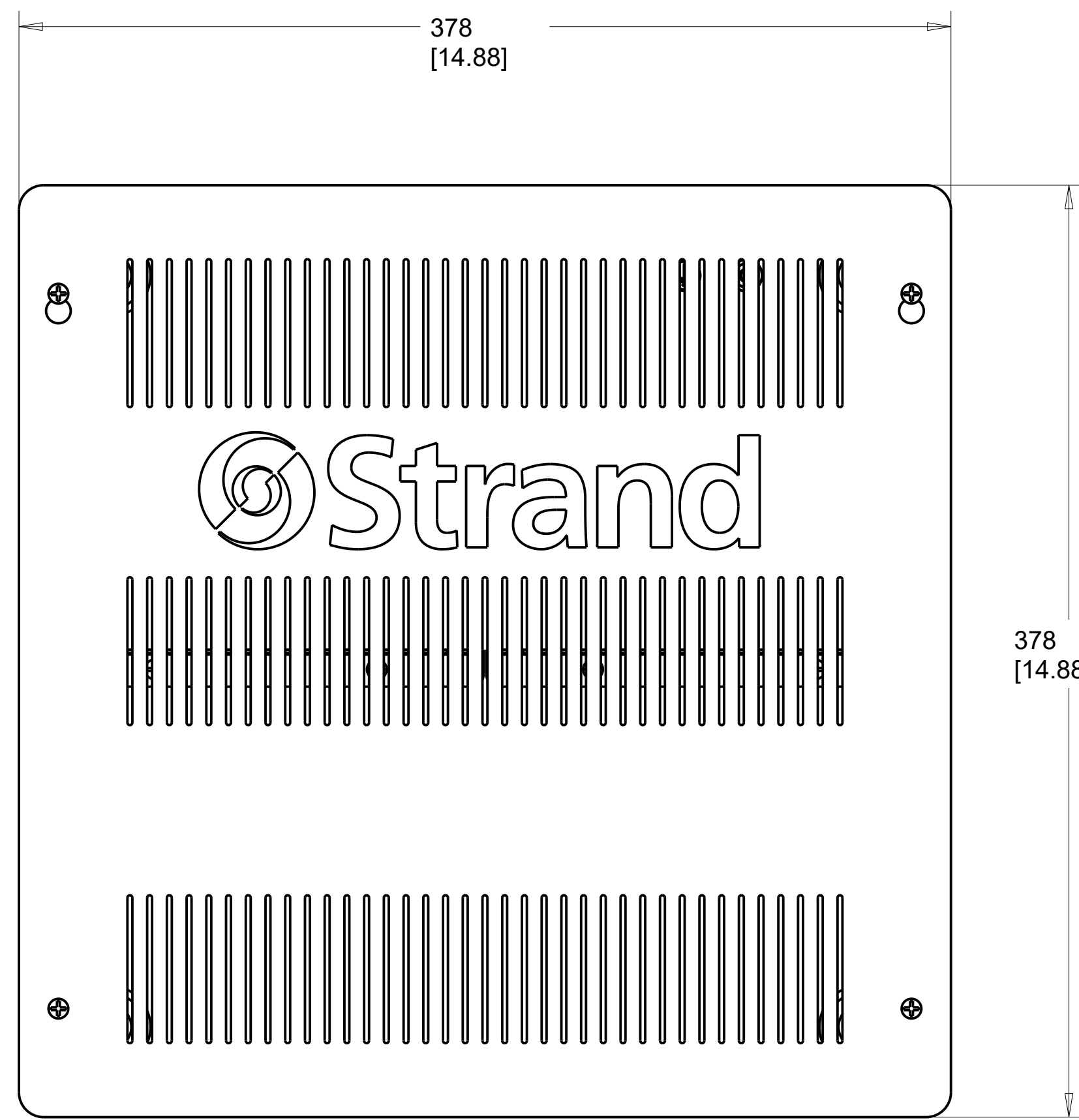
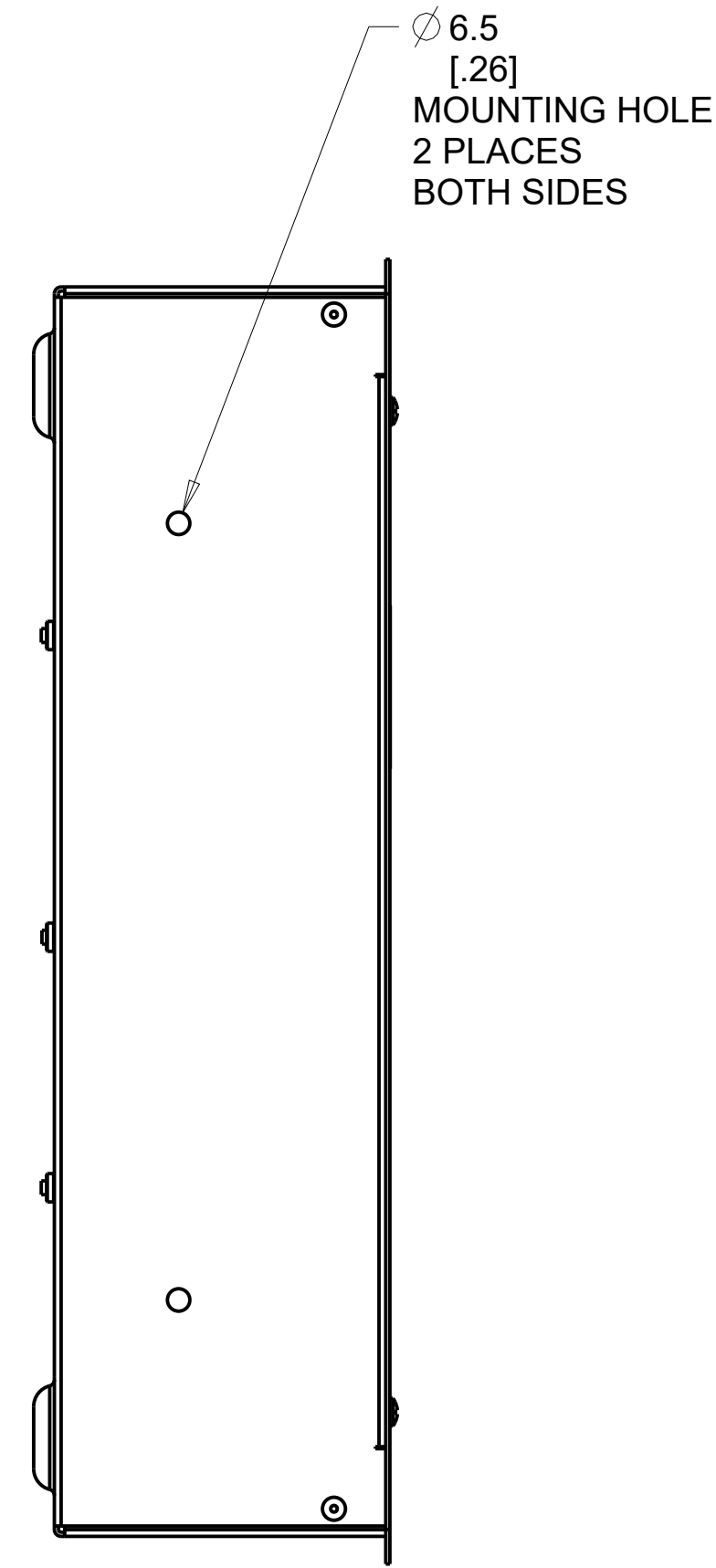
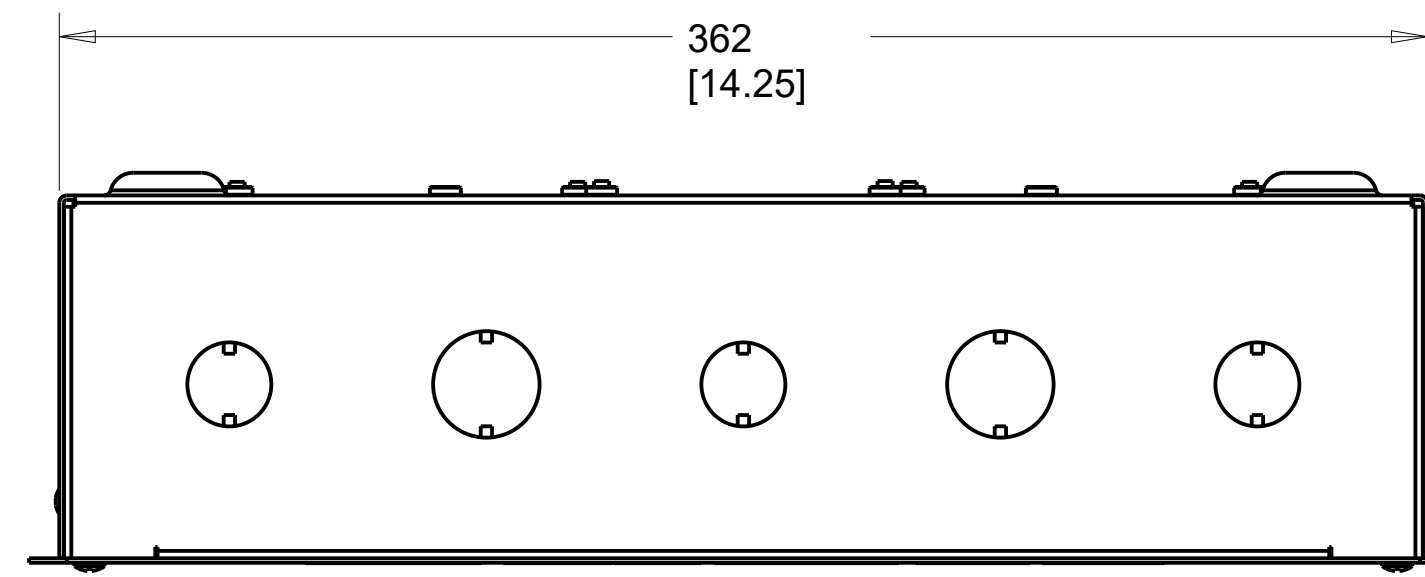

REAR VIEW

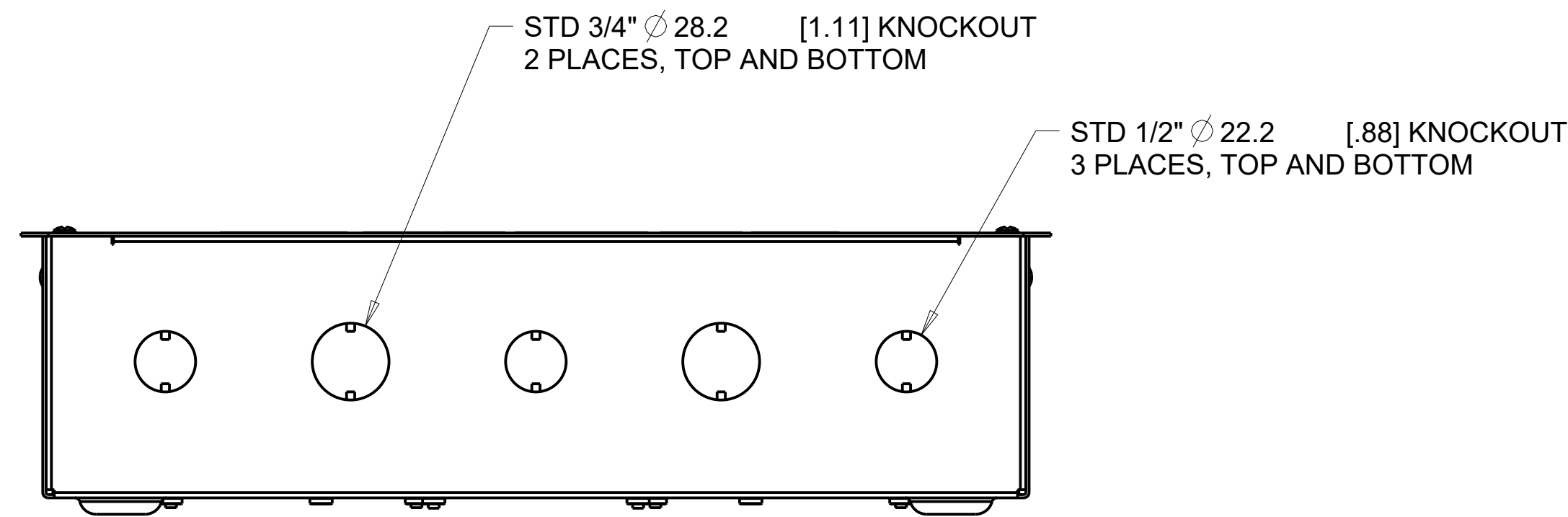

NOTES:
1. DIMENSION UNITS ARE MM/[IN].

		VISION.NET DIN RAIL ENCLOSURE-SMALL OUTLINE DIMENSION DRAWING			
Vari-Lite, LLC 10911 PETAL ST. DALLAS, TX 75238		DATE 2/21	SIZE D	REVISION C	DRAWING NUMBER 53906-001
© 2020 SIGNIFY HOLDING. ALL RIGHTS RESERVED		SCALE 1.00	CREO 3.0	SHEET 1	OF 2

4

1

3

2

1

D

D

C

C

B

B

A

A

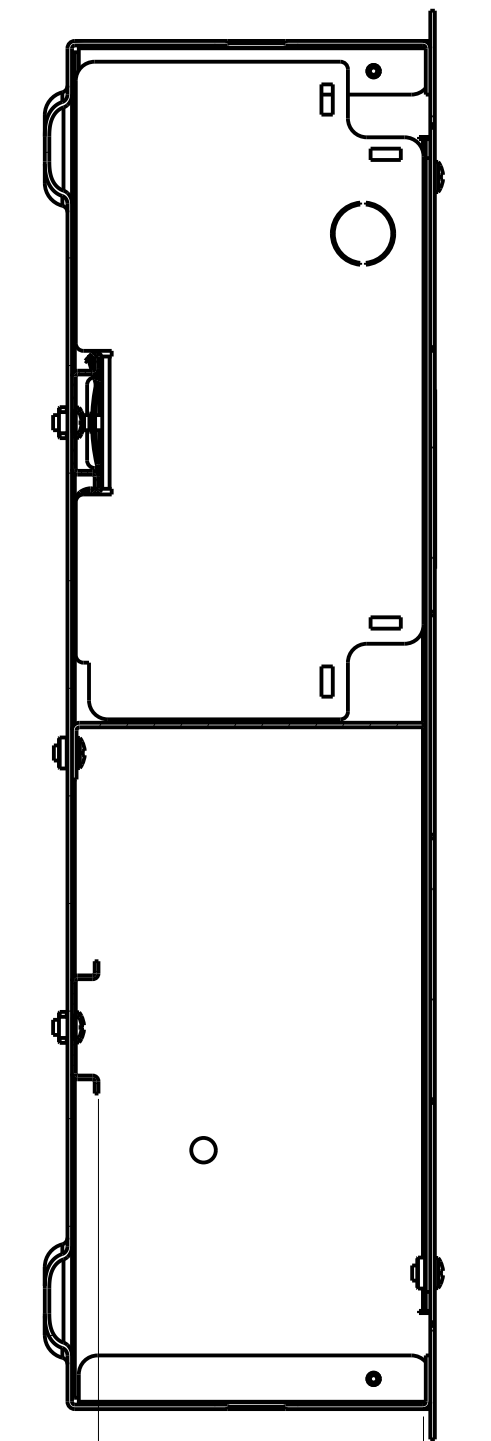

86
[3.39]
MAXIMUM UNIT HEIGHT
FROM TOP OF DIN RAIL

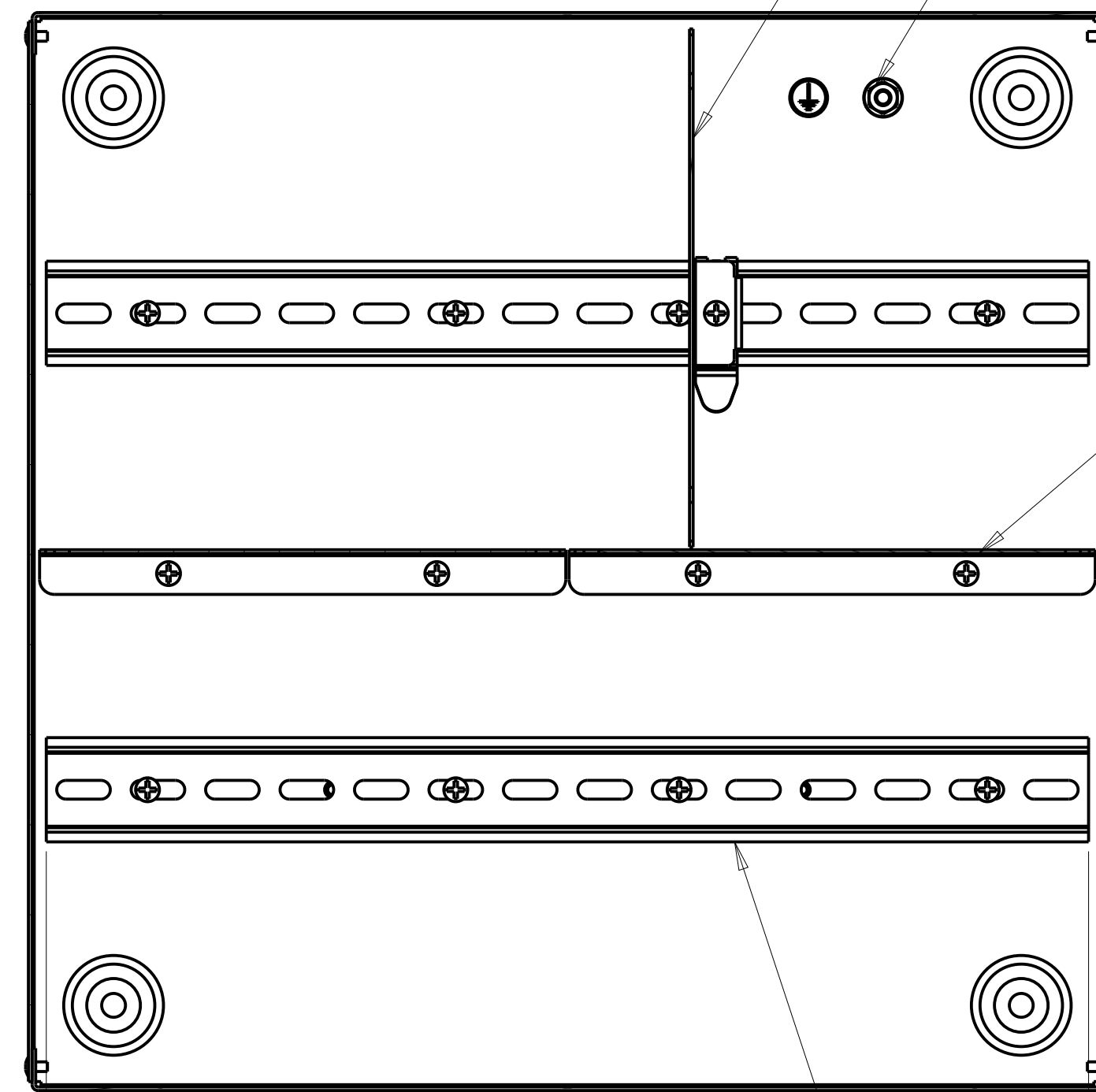

COVER REMOVED

TYPE TS35/7.5 DIN RAIL
20 SU EACH
2 PLACES

VERTICAL VOLTAGE BARRIER
REPOSITIONABLE LEFT AND RIGHT
AS REQUIRED

GROUND BOND STUD/NUT LOCATION (GRN)

HORIZONTAL VOLTAGE BARRIER
TWO INCLUDED
AS REQUIRED

350
[13.78]

		VISION.NET DIN RAIL ENCLOSURE-SMALL OUTLINE DIMENSION DRAWING			
Vari-Lite, LLC 10911 PETAL ST. DALLAS, TX 75238		DATE 2/21	SIZE D	REVISION C	DRAWING NUMBER 53906-001
© 2020 SIGNIFY HOLDING. ALL RIGHTS RESERVED		SCALE 0.50	CREO 3.0	SHEET 2	OF 2